

THRUST BEARINGS

- Thrust Needle Roller Bearings
- Thrust Roller Bearings



Structure and Features

IKO Thrust Bearings consist of a precisely made cage and rollers. They have high rigidity and high load capacities and can be used in small spaces.

Thrust Needle Roller Bearings incorporate needle rollers, while Thrust Roller Bearings incorporate cylindrical rollers. Various types of raceway rings are available, and suitable bearings can be selected according to the operating conditions.

When the bearing mounting surfaces of a machine are heat-treated and finished by grinding as raceways, Thrust Bearings can be used without raceway rings allowing the machine to be made more compact. They are most suited to applications where high accuracy is required at high speeds and under fluctuating heavy loads, such as driving mechanisms for automobiles, machine tools, and high-pressure pumps.

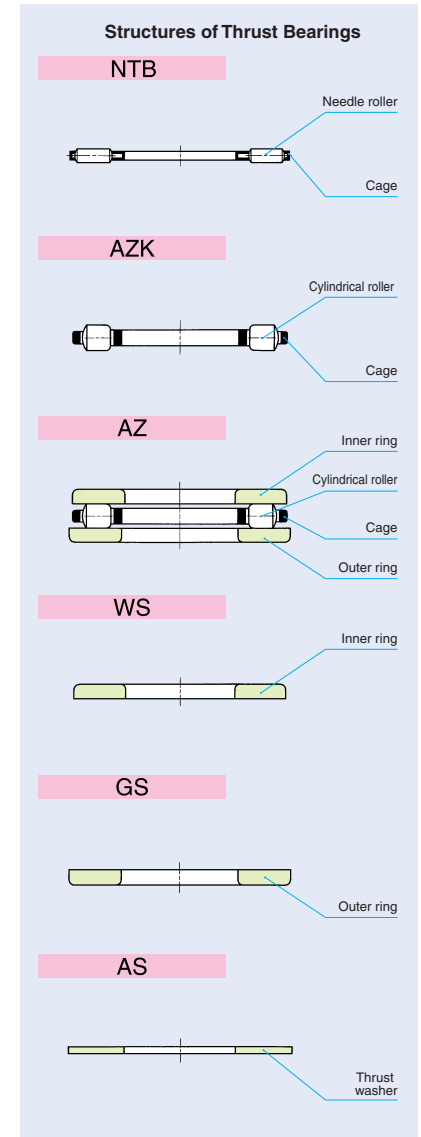

F
NTB
AS
AZK
WS-GS

Types

In  Thrust Bearings, the types shown in Table 1 are available.

Table 1.1 Type of bearing

Type	Thrust needle roller bearings	Thrust roller bearings	
		Without inner and outer rings	With inner and outer rings
Model code	NTB	AZK	AZ

Table 1.2 Type of bearing ring

Type	Inner ring	Outer ring	Thrust washer
Model code	WS	GS	AS

Thrust Needle Roller Bearings

These bearings consist of a cage made from a steel plate, which is precisely press formed and surface-hardened, and needle rollers with a diameter variation within $2\mu\text{m}$. They have a rigid structure and a high lubricant-retaining capacity.

As they have the lowest sectional height compared with other thrust bearings, they can be used instead of conventional thrust washers and can withstand high-speed rotations with a low coefficient of friction. Specially designed thin inner rings (WS) and outer rings (GS), and especially thin (1 mm thick) thrust washers (AS), are available for use in various applications.

These bearings are generally used by utilizing their inner surface as the guide surface.

Thrust Roller Bearings

In this series, the caged cylindrical rollers AZK and the complete bearings AZ in which AZK are combined with an inner ring (WS) and an outer ring (GS) are available.

The cage has a special precise structure which is highly rigid, and cylindrical rollers are outwardly arranged and guided by the cage with exact precision to enable them to withstand heavy loads even at high rotational speeds.

Owing to the high accuracy of the bearing height T , they are suitable for use in machine tools, ultra-high pressure pumps, etc.

These bearings are generally used by utilizing their inner surface as the guide surface.

Identification Number

The identification number of Thrust Bearings consists of a model code, dimensions and a classification symbol. Some examples are shown below.

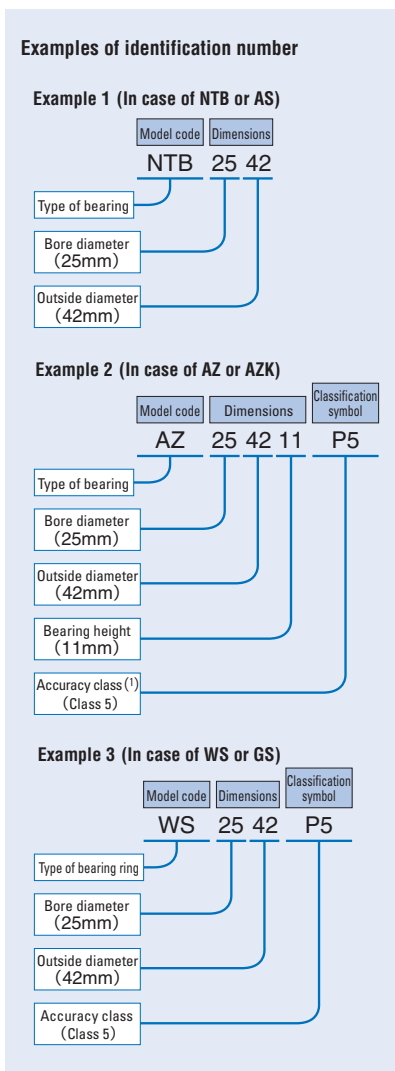

Note(1) Not applicable to the model AZK.

Accuracy

The accuracy of Thrust Bearings is based on JIS B 1514:2000 as shown in Table 2.

Table 2.1 Tolerances

unit: μm

Type of bearing	Item	Dimension	Dimension symbol	Tolerance
Thrust needle roller bearings	NTB	Bore diameter	d	E11
		Outside diameter	D	c12
		Width	D_w	Equivalent to JIS B 1506 Class 2
Thrust roller bearings	AZK	Bore diameter	d_c	As per Table 2.2
		Outside diameter	D_c	
		Width	D_w	$1 \leq D_w \leq 10$ Equivalent to JIS B 1506 Class 2 $10 < D_w \leq 30$ Equivalent to JIS B 1506 Class 3
	AZ	Height	T	As per Table 2.3
Inner rings	WS	Bore diameter	d	As per Table 2.4
		Outside diameter	D	b12
		Width	B	h11
Outer rings	GS	Bore diameter	d	B12
		Outside diameter	D	As per Table 2.4
		Width	B	h11
Thrust washers	AS	Bore diameter	d	E12
		Outside diameter	D	e12
		Width	s	± 50

Table 2.2 Tolerances of bore and outside diameters for AZK series

unit: μm

Nominal dimension mm	Δ_{d_c} Cage bore diameter deviation		Δ_{D_c} Cage outside diameter deviation		
	Over	Incl.	High	Low	
—	50	+100	0	0	— 300
50	100	+200	0	0	— 400
100	200	+300	0	0	— 500
200	300	+500	0	0	— 700
300	400	+700	0	0	— 1000
400	500	—	—	0	— 1200

Table 2.3 Tolerances of height for AZ series

unit: μm

Nominal bearing bore dia. mm	Δ_{T_3} Deviation of an actual bearing height			
	Over	Incl.	High	Low
—	18	30	0	— 75
18	30	50	0	— 75
30	50	80	0	— 100
50	80	120	0	— 125
80	120	180	0	— 150
120	180	250	0	— 175
180	250	315	0	— 200
250	315	400	0	— 225
315	400	500	0	— 300
400	500	—	0	— 400

Table 2.4 Tolerances and allowable values for WS and GS

unit: μm

d or D (1) Nominal bearing bore dia. or outside dia. mm		Inner ring			Outer ring			Inner ring or outer ring		
		Δ_{dmp}		V_{dsp}	Δ_{Dmp}		V_{Dsp}	S_i or S_e (2)		
		Single plane mean bore diameter deviation			Single plane mean outside diameter deviation			Bearing ring thickness variation		
Over	Incl.	High	Low	Max.	High	Low	Max.	Class 0	Class 6	Class 5
—	18	0	− 8	6	0	− 11	8	10	5	3
18	30	0	− 10	8	0	− 13	10	10	5	3
30	50	0	− 12	9	0	− 16	12	10	6	3
50	80	0	− 15	11	0	− 19	14	10	7	4
80	120	0	− 20	15	0	− 22	17	15	8	4
120	180	0	− 25	19	0	− 25	19	15	9	5
180	250	0	− 30	23	0	− 30	23	20	10	5
250	315	0	− 35	26	0	− 35	26	25	13	7
315	400	0	− 40	30	0	− 40	30	30	15	7
400	500	0	− 45	34	0	− 45	34	30	18	9

Notes(1) d for Δ_{dmp} and V_{dsp} , and D for Δ_{Dmp} and V_{Dsp} , respectively.

d for thickness variations of inner and outer rings.

(2) d_i for thickness variations of rings for NAX(I) and NBX(I).

Table 2.5 Permissible limit values for chamfer dimension

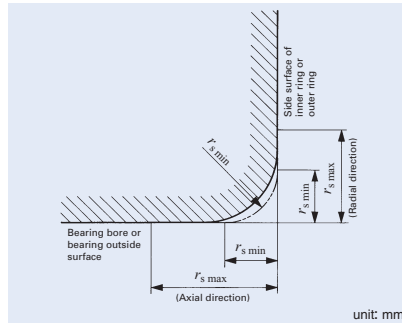

r_s min	Radial and axial directions	
	r_s min	r_s max
0.3	0.3	0.8
0.6	0.6	1.5
1	1	2.2
1.1	1.1	2.7
1.5	1.5	3.5
2	2	4
2.1	2.1	4.5
3	3	5.5
4	4	6.5
5	5	8

Fit

The recommended fits for Thrust Bearings are shown in Table 3.

Table 3 Recommended fits

Type of bearing		Tolerance class	
		Shaft	Housing bore
Thrust needle roller bearings	NTB	h8(h10)	—
Thrust roller bearings	AZK	h6(h8)	—
	AZ		H7(H9)
Inner rings	WS	h6(h8)	—
Outer rings	GS	—	H7(H9)
Thrust washers	AS	h8(h10)	—

Mounting

When mounting Thrust Bearings, the following items should be considered.

① When inner and outer rings are not used, the hardness of the raceway surfaces should be 58~64HRC, the effective hardening depth should be adequate, and the surface roughness should be less than $0.2 \mu\text{m} R_a$.

② When mounting inner and outer rings to shaft and housing bore, dimensions related to mounting should be based on the dimension tables.

Also, the mounting surfaces should be finished at right angles to the center axis and they should be sufficiently rigid.

③ To avoid elastic deformation, the thrust washer AS must be seated uniformly on its mating surface.

A small warp in an AS washer will be corrected automatically when an axial load is applied.

④ Thrust Roller Bearings are combinations of a copper alloy component and cylindrical rollers. When handling the AZK itself, care should be taken to prevent deformations, blemishes, etc.

F

NTB
AS
AZK
WS-GS

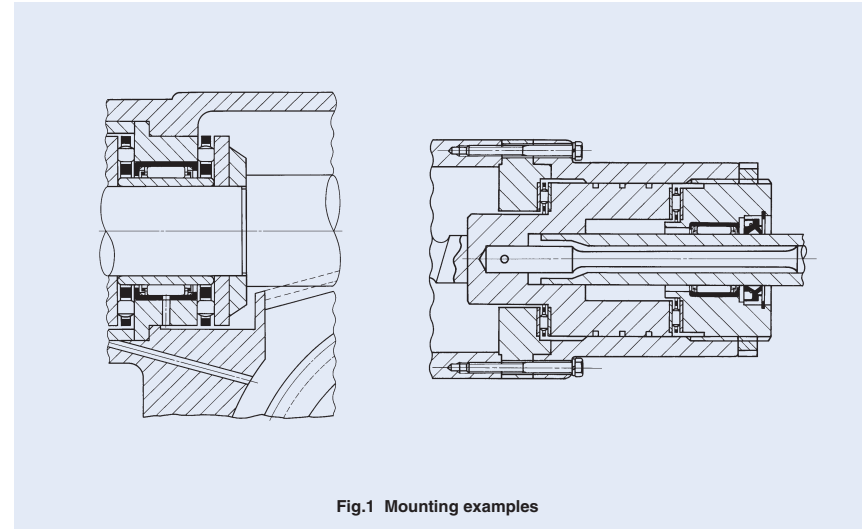
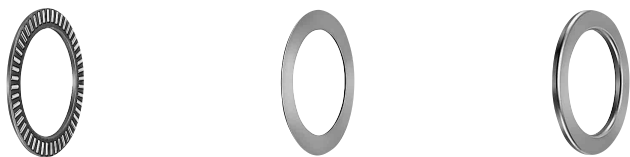

Fig.1 Mounting examples

THRUST BEARINGS

Thrust Needle Roller Bearings



Shaft dia. 10 – 85mm

Shaft dia. mm	Identification number						
	Thrust needle roller bearing	Mass (Ref.) g	Thrust washer	Mass (Ref.) g	Inner ring	Outer ring	Mass (Ref.) g
10	NTB 1024	3.3	AS 1024	2.9	WS 1024	GS 1024	8
12	NTB 1226	3.8	AS 1226	3.2	WS 1226	GS 1226	8.9
15	NTB 1528	4.1	AS 1528	3.4	WS 1528	GS 1528	9.3
16	NTB 1629	4.3	AS 1629	3.6	WS 1629	GS 1629	9.8
17	NTB 1730	4.5	AS 1730	3.7	WS 1730	GS 1730	10.2
18	NTB 1831	4.7	AS 1831	3.9	WS 1831	GS 1831	10.7
20	NTB 2035	6.1	AS 2035	5	WS 2035	GS 2035	13.8
25	NTB 2542	8.2	AS 2542	6.9	WS 2542	GS 2542	21
30	NTB 3047	9.4	AS 3047	7.9	WS 3047	GS 3047	24
35	NTB 3552	10.6	AS 3552	8.9	WS 3552	GS 3552	31.5
40	NTB 40603	22	AS 4060	12.1	WS 4060	GS 4060	42.5
45	NTB 4565	24.5	AS 4565	13.3	WS 4565	GS 4565	53.5
50	NTB 5070	26.5	AS 5070	14.5	WS 5070	GS 5070	58.5
55	NTB 5578	33.5	AS 5578	18.5	WS 5578	GS 5578	93
60	NTB 6085	38.5	AS 6085	22	WS 6085	GS 6085	105
65	NTB 6590	41.5	AS 6590	23.5	WS 6590	GS 6590	124
70	NTB 7095	61	AS 7095	25	WS 7095	GS 7095	132
75	NTB 75100	65	AS 75100	26.5	WS 75100	GS 75100	153
80	NTB 80105	68.5	AS 80105	28	WS 80105	GS 80105	162
85	NTB 85110	72	AS 85110	29.5	WS 85110	GS 85110	170

Notes⁽¹⁾ Minimum allowable value of chamfer dimension *r*
⁽²⁾ Allowable rotational speed applies to oil lubrication. For grease lubrication, a maximum of 25% of this value is allowable.

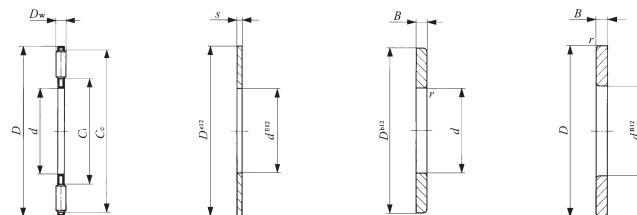

NTB AS WS GS

Boundary dimensions mm								Basic dynamic load rating C N	Basic static load rating C ₀ N	Allowable rotational speed ⁽²⁾ rpm
<i>d</i>	<i>D</i>	<i>D_w</i>	<i>s</i>	<i>B</i>	<i>r_{s min}</i> ⁽¹⁾	<i>C_i</i>	<i>C_c</i>			
10	24	2	1	2.75	0.3	14	22	7 820	23 900	15 000
12	26	2	1	2.75	0.3	16	24	8 340	26 900	13 000
15	28	2	1	2.75	0.3	18	26	8 830	29 900	12 000
16	29	2	1	2.75	0.3	19	27	9 070	31 400	11 000
17	30	2	1	2.75	0.3	20	28	9 320	32 900	11 000
18	31	2	1	2.75	0.3	21	29	9 550	34 400	10 000
20	35	2	1	2.75	0.3	23	33	11 700	46 500	9 000
25	42	2	1	3	0.6	29	40	14 400	64 700	7 500
30	47	2	1	3	0.6	34	45	15 400	73 300	6 500
35	52	2	1	3.5	0.6	39	50	16 300	81 900	5 500
40	60	3	1	3.5	0.6	45	57	24 200	108 000	5 000
45	65	3	1	4	0.6	50	62	25 900	121 000	4 500
50	70	3	1	4	0.6	55	67	27 600	135 000	4 000
55	78	3	1	5	0.6	61	75	32 400	171 000	4 000
60	85	3	1	4.75	1	66	82	38 200	219 000	3 500
65	90	3	1	5.25	1	71	87	40 100	237 000	3 000
70	95	4	1	5.25	1	75	91	47 400	244 000	3 000
75	100	4	1	5.75	1	80	96	48 400	256 000	3 000
80	105	4	1	5.75	1	85	101	49 500	267 000	2 500
85	110	4	1	5.75	1	90	106	50 300	279 000	2 500

F
 NTB
 AS
 AZK
 WS-GS

THRUST BEARINGS

Thrust Needle Roller Bearings

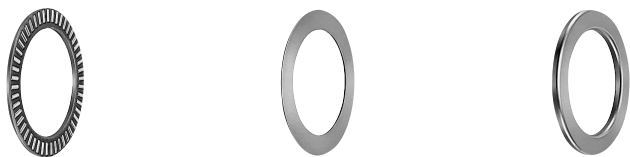

Shaft dia. 90 – 130mm

Shaft dia. mm	Identification number						
	Thrust needle roller bearing	Mass (Ref.) g	Thrust washer	Mass (Ref.) g	Inner ring	Outer ring	Mass (Ref.) g
90	NTB 90120	92	AS 90120	38	WS 90120	GS 90120	250
100	NTB 100135	119	AS 100135	50	WS 100135	GS 100135	350
110	NTB 110145	129	—	—	WS 110145	GS 110145	380
120	NTB 120155	139	—	—	WS 120155	GS 120155	410
130	NTB 130170	225	—	—	WS 130170	GS 130170	660

Notes⁽¹⁾ Minimum allowable value of chamfer dimension *r*
⁽²⁾ Allowable rotational speed applies to oil lubrication. For grease lubrication, a maximum of 25% of this value is allowable.

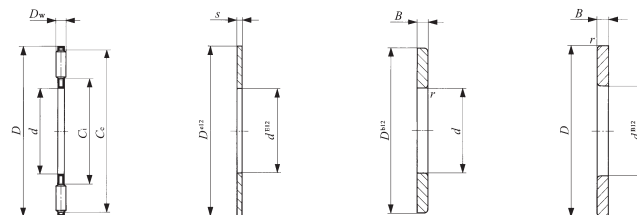

NTB AS WS GS

Boundary dimensions mm								Basic dynamic load rating <i>C</i> N	Basic static load rating <i>C</i> ₀ N	Allowable rotational speed ⁽²⁾ rpm
<i>d</i>	<i>D</i>	<i>D</i> _w	<i>s</i>	<i>B</i>	<i>r</i> _{s min} ⁽¹⁾	<i>C</i> _i	<i>C</i> _c			
90	120	4	1	6.5	1	96	116	64 500	394 000	2 500
100	135	4	1	7	1	107	131	80 300	541 000	2 000
110	145	4	—	7	1	117	141	83 200	578 000	2 000
120	155	4	—	7	1	127	151	87 900	634 000	1 800
130	170	5	—	9	1	137	165	120 000	839 000	1 700

F
 NTB
 AS
 AZK
 WS-GS

THRUST BEARINGS

Thrust Roller Bearings



Shaft dia. 10 – 65mm

Shaft dia. mm	Identification number							
	Thrust roller bearing	Mass (Ref.) g	Thrust roller bearing	Mass (Ref.) g	Inner ring	Outer ring	Mass (Ref.) g	
10	AZ 10249	24.6	AZK 10243.5	8.6	WS 1024	GS 1024	8	
12	AZ 12269	26.5	AZK 12263.5	8.7	WS 1226	GS 1226	8.9	
15	AZ 15289	28	AZK 15283.5	9.4	WS 1528	GS 1528	9.3	
17	AZ 17309	30.5	AZK 17303.5	10.1	WS 1730	GS 1730	10.2	
20	AZ 203510	45.5	AZK 20354.5	17.9	WS 2035	GS 2035	13.8	
25	AZ 254211	70	AZK 25425	28	WS 2542	GS 2542	21	
30	AZ 304711	79	AZK 30475	31	WS 3047	GS 3047	24	
	AZ 305216	160	AZK 30527.5	70	WS 3052	GS 3052	45	
35	AZ 355212	99	AZK 35525	36	WS 3552	GS 3552	31.5	
	AZ 356218	260	AZK 35627.5	98	WS 3562	GS 3562	81	
40	AZ 406013	139	AZK 40606	54	WS 4060	GS 4060	42.5	
	AZ 406819	310	AZK 40689	132	WS 4068	GS 4068	89	
45	AZ 456514	169	AZK 45656	62	WS 4565	GS 4565	53.5	
	AZ 457320	360	AZK 45739	144	WS 4573	GS 4573	108	
50	AZ 507014	185	AZK 50706	68	WS 5070	GS 5070	58.5	
	AZ 507822	430	AZK 507811	194	WS 5078	GS 5078	118	
55	AZ 557816	275	AZK 55786	89	WS 5578	GS 5578	93	
	AZ 559025	725	AZK 559011	275	WS 5590	GS 5590	225	
60	AZ 608517	345	AZK 60857.5	135	WS 6085	GS 6085	105	
	AZ 609526	770	AZK 609511	290	WS 6095	GS 6095	240	
	AZ 6013026	2 090	AZK 6013010	790	WS 60130	GS 60130	650	
65	AZ 659018	380	AZK 65907.5	132	WS 6590	GS 6590	124	
	AZ 6510027	860	AZK 6510011	310	WS 65100	GS 65100	275	

Notes⁽¹⁾ Minimum allowable value of chamfer dimension *r*
⁽²⁾ Allowable rotational speed applies to oil lubrication. For grease lubrication, a maximum of 25% of this value is allowable.

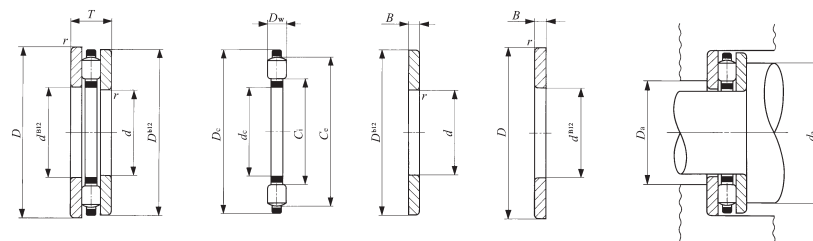

AZ AZK WS GS

Boundary dimensions mm											Standard mounting dimensions mm		Basic dynamic load rating	Basic static load rating	Allowable rotational speed ⁽²⁾
<i>d</i>	<i>D</i>	<i>T</i>	<i>d_c</i>	<i>D_c</i>	<i>D_w</i>	<i>B</i>	<i>r_{s min}</i> ⁽¹⁾	<i>C_i</i>	<i>C_e</i>	<i>d_a</i> Min.	<i>D_a</i> Max.	<i>C</i>	<i>C₀</i>	rpm	
10	24	9	10.04	23.6	3.5	2.75	0.3	13	21	21	13	8 990	19 100	18 000	
12	26	9	12.04	25.6	3.5	2.75	0.3	15	23	23	16	10 400	23 900	16 000	
15	28	9	15.04	27.6	3.5	2.75	0.3	17	25	25	18	10 200	23 900	14 000	
17	30	9	17.04	29.6	3.5	2.75	0.3	19	27	27	20	11 400	28 600	13 000	
20	35	10	20.04	34.6	4.5	2.75	0.3	22	33	33	23	19 000	48 700	11 000	
25	42	11	25.05	41.6	5	3	0.6	28	39	39	28	22 700	60 700	9 000	
30	47	11	30.05	46.5	5	3	0.6	33	44	44	33	27 400	81 000	8 000	
30	52	16	30.05	51.5	7.5	4.25	0.6	35	49	48	36	38 400	95 700	7 500	
35	52	12	35.05	51.5	5	3.5	0.6	38	49	49	39	29 100	91 100	7 000	
35	62	18	35.05	61.5	7.5	5.25	1	42	58	57	43	47 900	135 000	6 500	
40	60	13	40.05	59.5	6	3.5	0.6	44	57	57	44	41 700	133 000	6 000	
40	68	19	40.05	67.5	9	5	1	45	64	64	46	68 700	195 000	5 500	
45	65	14	45.05	64.5	6	4	0.6	49	62	62	49	40 800	133 000	5 500	
45	73	20	45.05	72.5	9	5.5	1	50	69	69	51	75 700	227 000	5 000	
50	70	14	50.05	69.5	6	4	0.6	54	67	67	54	43 300	148 000	5 000	
50	78	22	50.05	77.5	11	5.5	1	55	74	73	56	84 300	232 000	4 500	
55	78	16	55.05	77.5	6	5	0.6	59	75	75	60	51 700	192 000	4 500	
55	90	25	55.05	89.5	11	7	1	63	85	84	63	108 000	332 000	4 000	
60	85	17	60.05	84.5	7.5	4.75	1	65	81	81	66	64 600	224 000	4 000	
60	95	26	60.05	94.5	11	7.5	1	68	90	89	68	106 000	332 000	4 000	
60	130	26	60.05	129.5	10	8	1.5	79	119	119	80	158 000	634 000	3 000	
65	90	18	65.05	89.5	7.5	5.25	1	70	86	86	71	68 300	247 000	4 000	
65	100	27	65.05	99.5	11	8	1	73	95	94	73	116 000	379 000	3 500	

F
 NTB
 AS
 AZK
 WS-GS

THRUST BEARINGS

Thrust Roller Bearings



Shaft dia. 70 – 130mm

Shaft dia. mm	Identification number						
	Thrust roller bearing	Mass (Ref.) g	Thrust roller bearing	Mass (Ref.) g	Inner ring	Outer ring	Mass (Ref.) g
70	AZ 709518	420	AZK 70957.5	156	WS 7095	GS 7095	132
	AZ 7010527	905	AZK 7010511	325	WS 70105	GS 70105	290
	AZ 7014026	2 250	AZK 7014010	890	WS 70140	GS 70140	680
75	AZ 7510019	465	AZK 751007.5	159	WS 75100	GS 75100	153
	AZ 7511027	960	AZK 7511011	340	WS 75110	GS 75110	310
80	AZ 8010519	495	AZK 801057.5	171	WS 80105	GS 80105	162
	AZ 8011528	1 060	AZK 8011511	370	WS 80115	GS 80115	345
	AZ 8015026	2 500	AZK 8015010	920	WS 80150	GS 80150	790
85	AZ 8511019	530	AZK 851107.5	190	WS 85110	GS 85110	170
	AZ 8512531	1 460	AZK 8512512	510	WS 85125	GS 85125	475
90	AZ 9012022	790	AZK 901209	290	WS 90120	GS 90120	250
	AZ 9013535	2 040	AZK 9013514	750	WS 90135	GS 90135	645
	AZ 9016026	2 710	AZK 9016010	1 000	WS 90160	GS 90160	855
100	AZ 10013525	1 190	AZK 10013511	490	WS 100135	GS 100135	350
	AZ 10015038	2 720	AZK 10015015	980	WS 100150	GS 100150	870
	AZ 10019039	5 960	AZK 10019015	2 120	WS 100190	GS 100190	1 920
110	AZ 11014525	1 350	AZK 11014511	590	WS 110145	GS 110145	380
	AZ 11016040	3 220	AZK 11016017	1 320	WS 110160	GS 110160	950
	AZ 11020039	6 400	AZK 11020015	2 280	WS 110200	GS 110200	2 060
120	AZ 12015525	1 450	AZK 12015511	630	WS 120155	GS 120155	410
	AZ 12017542	4 020	AZK 12017518	1 640	WS 120175	GS 120175	1 190
	AZ 12022039	7 730	AZK 12022015	2 730	WS 120220	GS 120220	2 500
130	AZ 13017030	2 180	AZK 13017012	860	WS 130170	GS 130170	660
	AZ 13018542	4 300	AZK 13018518	1 760	WS 130185	GS 130185	1 270
	AZ 13023039	8 240	AZK 13023015	2 940	WS 130230	GS 130230	2 650

Notes⁽¹⁾ Minimum allowable value of chamfer dimension *r*
⁽²⁾ Allowable rotational speed applies to oil lubrication. For grease lubrication, a maximum of 25% of this value is allowable.

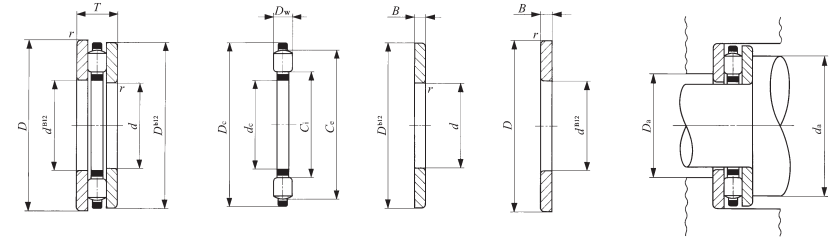

AZ AZK WS GS

Boundary dimensions mm											Standard mounting dimensions mm		Basic dynamic load rating C N	Basic static load rating C ₀ N	Allowable rotational speed ⁽²⁾ rpm
<i>d</i>	<i>D</i>	<i>T</i>	<i>d_c</i>	<i>D_c</i>	<i>D_w</i>	<i>B</i>	<i>r_{s min}</i> ⁽¹⁾	<i>C_i</i>	<i>C_e</i>	<i>d_a</i> Min.	<i>D_a</i> Max.				
70	95	18	70.05	94.5	7.5	5.25	1	75	91	91	76	72 000	269 000	3 500	
70	105	27	70.05	104.5	11	8	1	78	100	99	78	114 000	379 000	3 500	
70	140	26	70.05	139.5	10	8	1.1	89	129	129	90	169 000	713 000	3 000	
75	100	19	75.05	99.5	7.5	5.75	1	80	96	96	81	71 100	269 000	3 500	
75	110	27	75.05	109.5	11	8	1	83	105	104	83	123 000	427 000	3 000	
80	105	19	80.05	104.5	7.5	5.75	1	85	101	101	86	74 500	292 000	3 000	
80	115	28	80.05	114.5	11	8.5	1	88	110	109	88	122 000	427 000	3 000	
80	150	26	80.05	149.5	10	8	1.5	99	139	139	100	180 000	792 000	2 500	
85	110	19	85.05	109.5	7.5	5.75	1	90	106	106	91	77 800	314 000	3 000	
85	125	31	85.05	124.5	12	9.5	1	95	119	118	95	145 000	513 000	3 000	
90	120	22	90.05	119.5	9	6.5	1	97	116	115	97	99 700	390 000	3 000	
90	135	35	90.05	134.5	14	10.5	1.1	100	129	128	101	181 000	626 000	2 500	
90	160	26	90.05	159.5	10	8	1.5	109	149	149	110	189 000	871 000	2 500	
100	135	25	100.05	134.5	11	7	1	108	130	129	108	136 000	522 000	2 500	
100	150	38	100.05	149.5	15	11.5	1.1	112	143	142	113	219 000	796 000	2 500	
100	190	39	100.1	189.3	15	12	1.5	119	179	177	120	333 000	1 420 000	2 000	
110	145	25	110.1	144.5	11	7	1	118	140	139	118	142 000	569 000	2 500	
110	160	40	110.1	159.5	17	11.5	1.1	120	154	153	121	282 000	1 030 000	2 000	
110	200	39	110.1	199.3	15	12	2	129	188	187	130	388 000	1 770 000	2 000	
120	155	25	120.1	154.5	11	7	1	128	150	149	128	149 000	617 000	2 000	
120	175	42	120.1	174.5	18	12	1.1	132	168	167	133	313 000	1 160 000	2 000	
120	220	39	120.1	219	15	12	2.1	141	207	206	142	415 000	1 980 000	1 800	
130	170	30	130.1	169.5	12	9	1	140	164	163	140	176 000	741 000	2 000	
130	185	42	130.1	184.5	18	12	1.5	142	178	177	143	333 000	1 290 000	1 900	
130	230	39	130.1	229	15	12	2.1	151	217	216	152	440 000	2 180 000	1 700	

THRUST BEARINGS

Thrust Roller Bearings



Shaft dia. 140 – 280mm

Shaft dia. mm	Identification number						
	Thrust roller bearing	Mass (Ref.) g	Thrust roller bearing	Mass (Ref.) g	Inner ring	Outer ring	Mass (Ref.) g
140	AZ 14018031	2 410	AZK 14018012	920	WS 140180	GS 140180	745
	AZ 14019542	4 560	AZK 14019518	1 860	WS 140195	GS 140195	1 350
	AZ 14024039	8 680	AZK 14024015	3 100	WS 140240	GS 140240	2 790
150	AZ 15019031	2 560	AZK 15019012	980	WS 150190	GS 150190	790
	AZ 15020542	4 840	AZK 15020518	1 980	WS 150205	GS 150205	1 430
	AZ 15025039	9 140	AZK 15025015	3 260	WS 150250	GS 150250	2 940
160	AZ 16020031	2 710	AZK 16020012	1 030	WS 160200	GS 160200	840
	AZ 16027039	10 800	AZK 16027015	3 840	WS 160270	GS 160270	3 480
170	AZ 17023045	6 220	AZK 17023019	2 420	WS 170230	GS 170230	1 900
	AZ 17028039	11 300	AZK 17028015	4 020	WS 170280	GS 170280	3 640
180	AZ 18024045	6 540	AZK 18024019	2 540	WS 180240	GS 180240	2 000
	AZ 18031039	14 600	AZK 18031015	5 200	WS 180310	GS 180310	4 700
190	AZ 19025548	8 060	AZK 19025520	3 100	WS 190255	GS 190255	2 480
	AZ 19032039	15 000	AZK 19032015	5 280	WS 190320	GS 190320	4 860
200	AZ 20026548	8 430	AZK 20026520	3 250	WS 200265	GS 200265	2 590
	AZ 20034039	17 200	AZK 20034015	6 120	WS 200340	GS 200340	5 540
220	AZ 22029050	10 400	AZK 22029022	4 280	WS 220290	GS 220290	3 060
	AZ 22036052	24 000	AZK 22036020	8 000	WS 220360	GS 220360	8 000
240	AZ 24031554	13 200	AZK 24031524	5 520	WS 240315	GS 240315	3 840
	AZ 24038052	26 500	AZK 24038020	9 440	WS 240380	GS 240380	8 530
260	AZ 26034055	15 400	AZK 26034025	6 600	WS 260340	GS 260340	4 400
	AZ 26042080	51 600	AZK 26042030	18 200	WS 260420	GS 260420	16 700
280	AZ 28044080	54 600	AZK 28044030	19 200	WS 280440	GS 280440	17 700

Notes⁽¹⁾ Minimum allowable value of chamfer dimension *r*
⁽²⁾ Allowable rotational speed applies to oil lubrication. For grease lubrication, a maximum of 25% of this value is allowable.

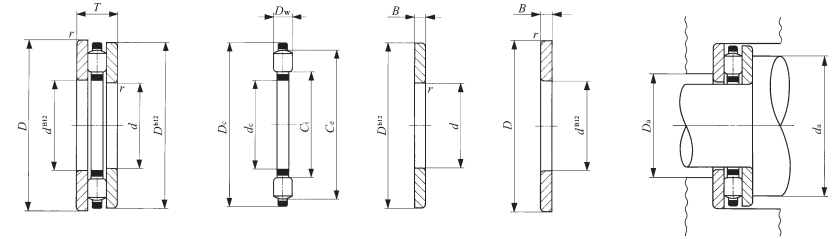

AZ AZK WS GS

Boundary dimensions mm												Standard mounting dimensions mm		Basic dynamic load rating C N	Basic static load rating C ₀ N	Allowable rotational speed ⁽²⁾ rpm
<i>d</i>	<i>D</i>	<i>T</i>	<i>d_c</i>	<i>D_c</i>	<i>D_w</i>	<i>B</i>	<i>r_{s min}</i> ⁽¹⁾	<i>C_i</i>	<i>C_e</i>	<i>d_a</i> Min.	<i>D_a</i> Max.					
140	180	31	140.1	179.5	12	9.5	1	150	174	173	150	184 000	798 000	1 900		
140	195	42	140.1	194.5	18	12	1.5	152	188	187	153	353 000	1 420 000	1 800		
140	240	39	140.1	239	15	12	2.1	161	227	226	162	435 000	2 180 000	1 600		
150	190	31	150.1	189.5	12	9.5	1	160	184	183	160	181 000	798 000	1 800		
150	205	42	150.1	204.5	18	12	1.5	162	198	197	163	349 000	1 420 000	1 700		
150	250	39	150.1	249	15	12	2.1	171	237	236	172	459 000	2 380 000	1 500		
160	200	31	160.1	199.5	12	9.5	1	170	194	193	170	189 000	855 000	1 700		
160	270	39	160.1	269	15	12	3	183	256	255	184	519 000	2 850 000	1 400		
170	230	45	170.1	229	19	13	1.5	183	221	220	184	406 000	1 730 000	1 500		
170	280	39	170.1	279	15	12	3	193	266	265	194	543 000	3 070 000	1 300		
180	240	45	180.1	239	19	13	1.5	193	231	230	194	426 000	1 870 000	1 400		
180	310	39	180.1	308	15	12	3	204	294	293	205	619 000	3 710 000	1 200		
190	255	48	190.1	254	20	14	2	205	245	244	206	470 000	2 080 000	1 300		
190	320	39	190.1	318	15	12	4	214	304	303	215	647 000	3 980 000	1 200		
200	265	48	200.15	264	20	14	2	215	255	254	216	465 000	2 080 000	1 300		
200	340	39	200.15	338	15	12	4	227	323	322	228	710 000	4 580 000	1 100		
220	290	50	220.15	289	22	14	2	236	280	278	237	557 000	2 530 000	1 300		
220	360	52	220.15	358	20	16	4	246	343	342	247	943 000	5 520 000	1 000		
240	315	54	240.15	314	24	15	2	256	304	302	257	695 000	3 250 000	1 100		
240	380	52	240.15	378	20	16	4	266	363	362	267	977 000	5 910 000	1 000		
260	340	55	260.15	339	25	15	2.1	278	328	326	279	739 000	3 510 000	1 000		
260	420	80	260.15	418	30	25	5	289	402	400	291	1 430 000	7 490 000	900		
280	440	80	280.15	438	30	25	5	309	422	420	311	1 420 000	7 490 000	800		

F
NTB
AS
AZK
WS-GS